

ADUI reist um die Welt!

ADUI travels around the world!

ADUI 环游世界！

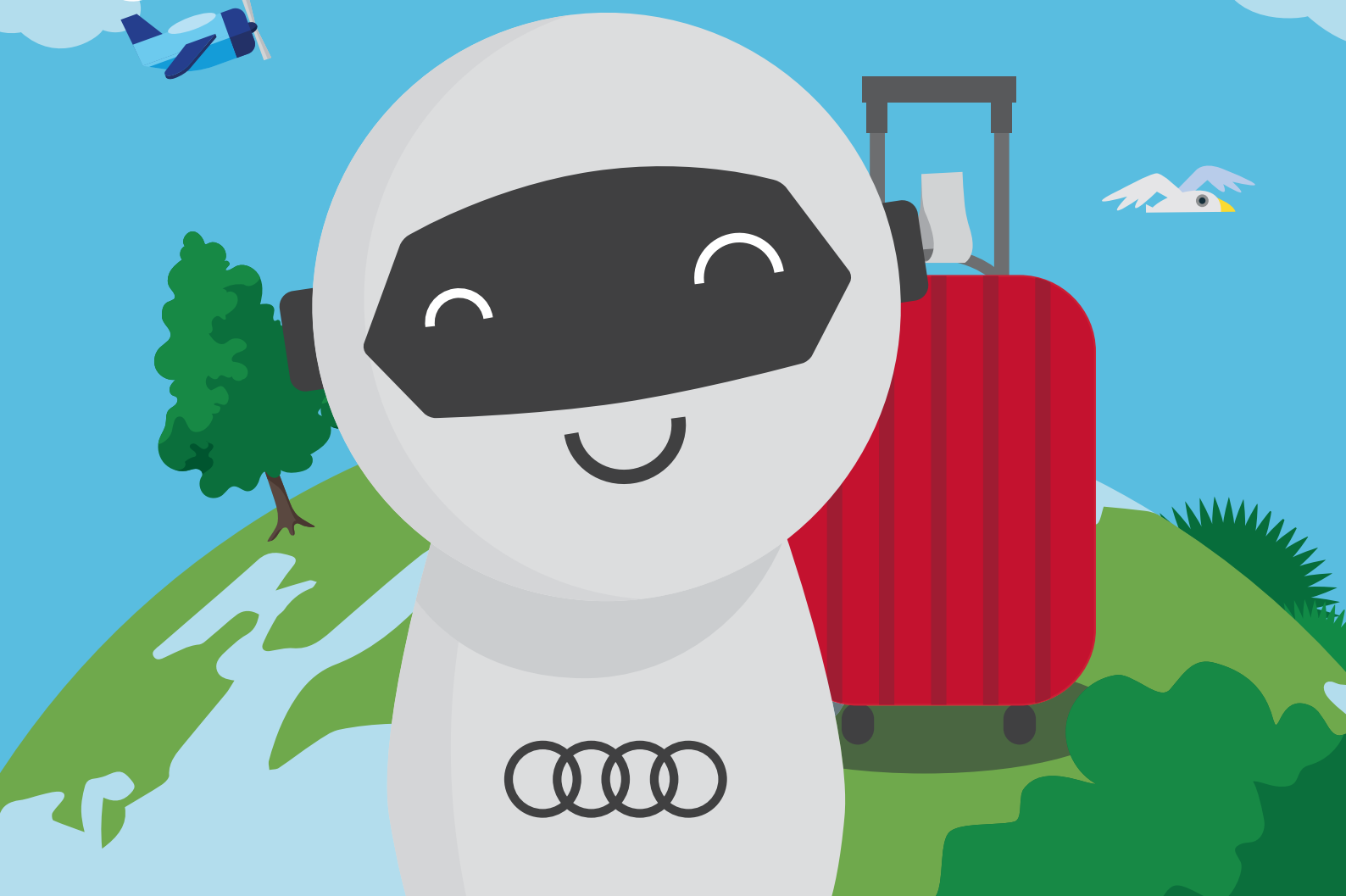



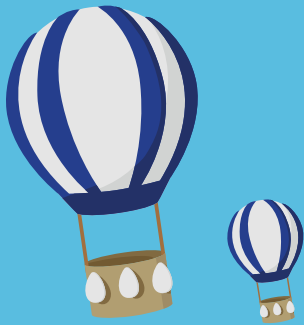

Der kleine Roboter ADUI reist um die Welt um für seinen Audi e-tron alternative Energie zu finden.

The little robot ADUI is travelling around the world, looking for alternative energies for his Audi e-tron.

小型机器人ADUI在世界各地旅行，
为其奥迪e-tron找替代能源。

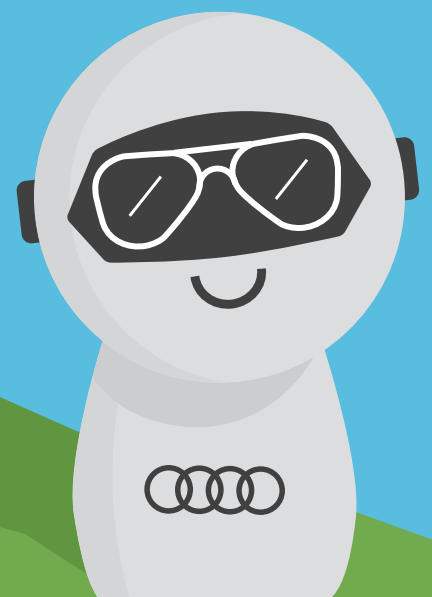

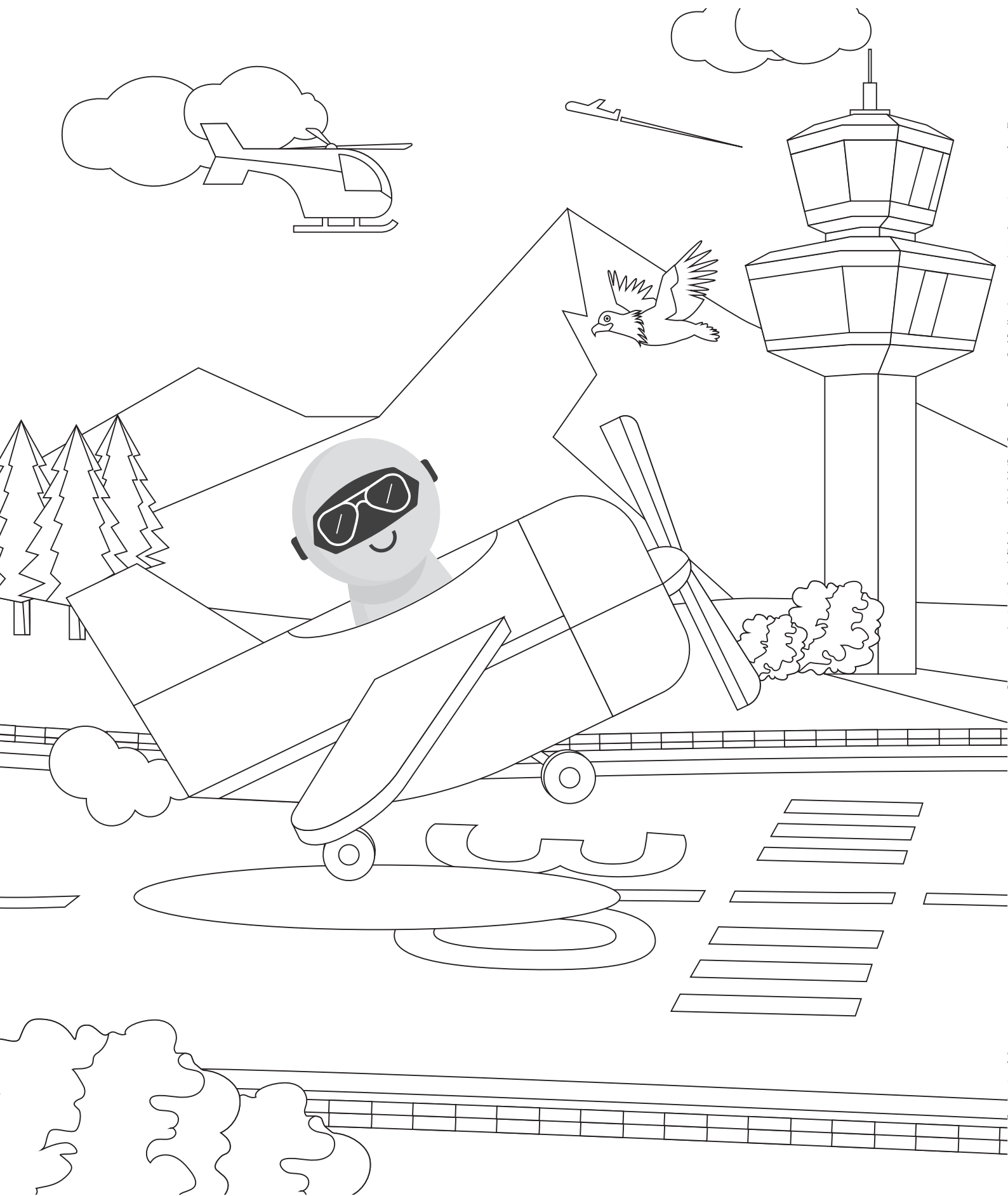

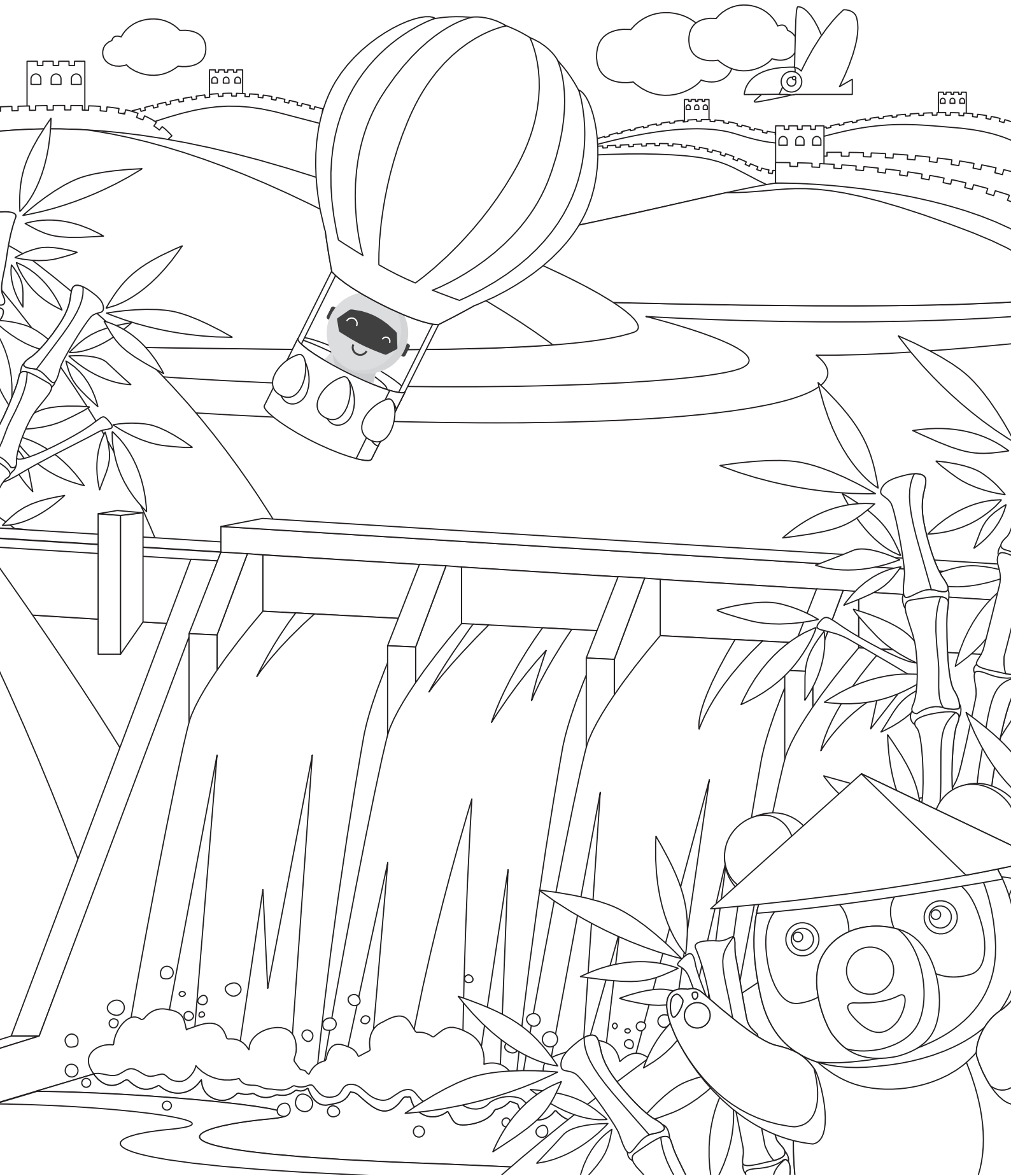

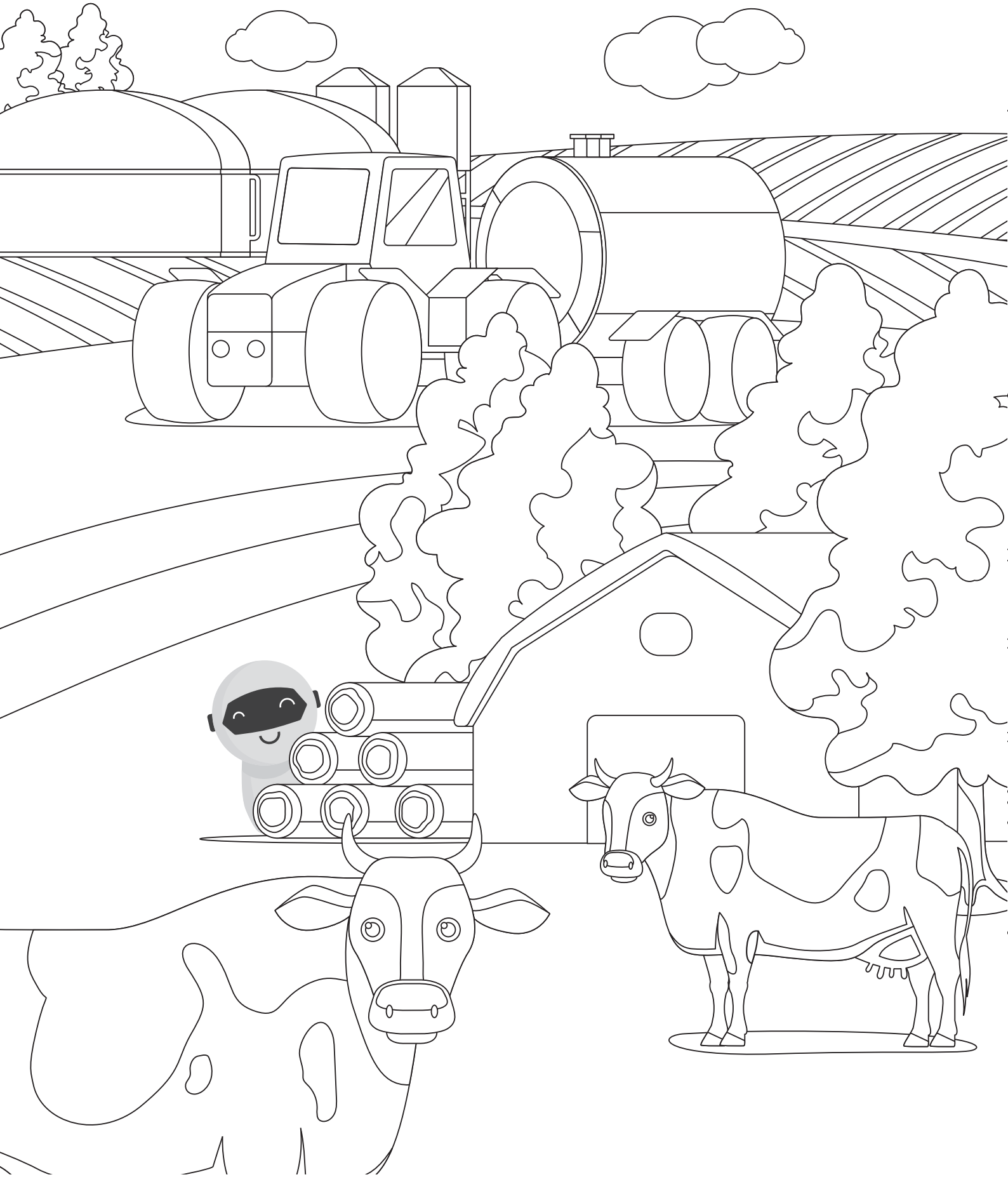

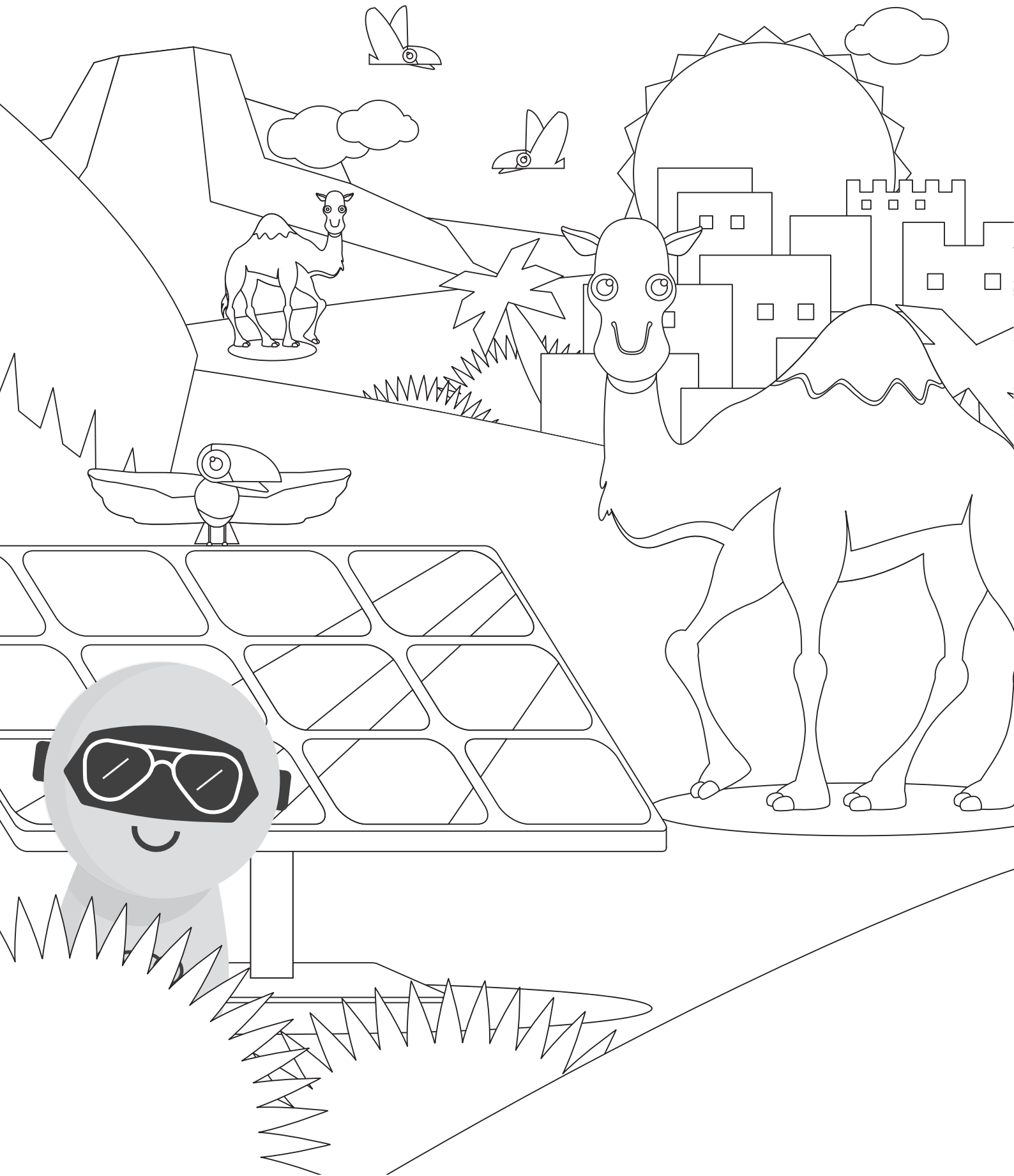

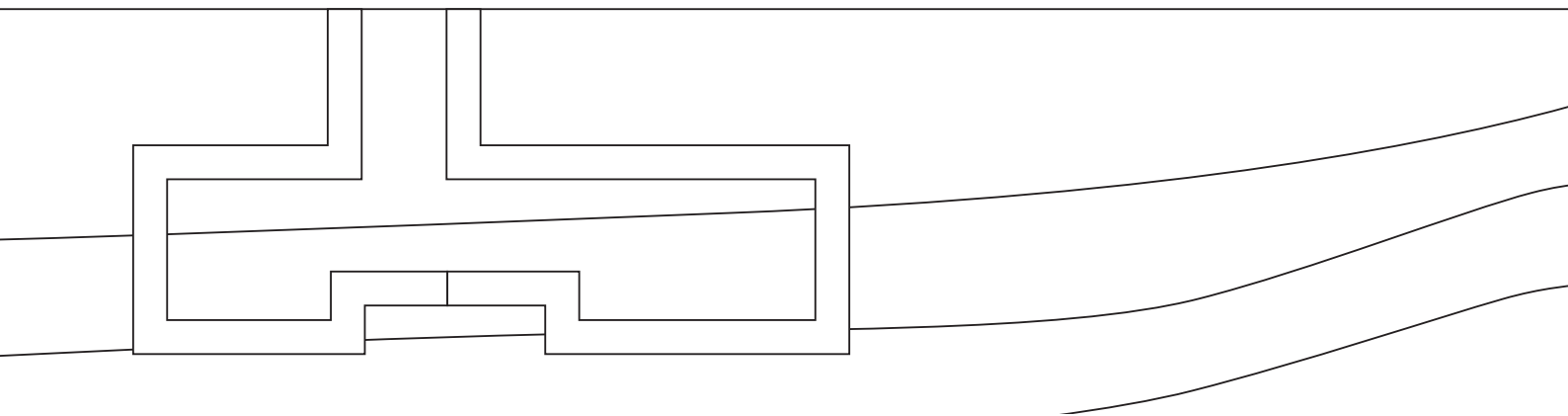





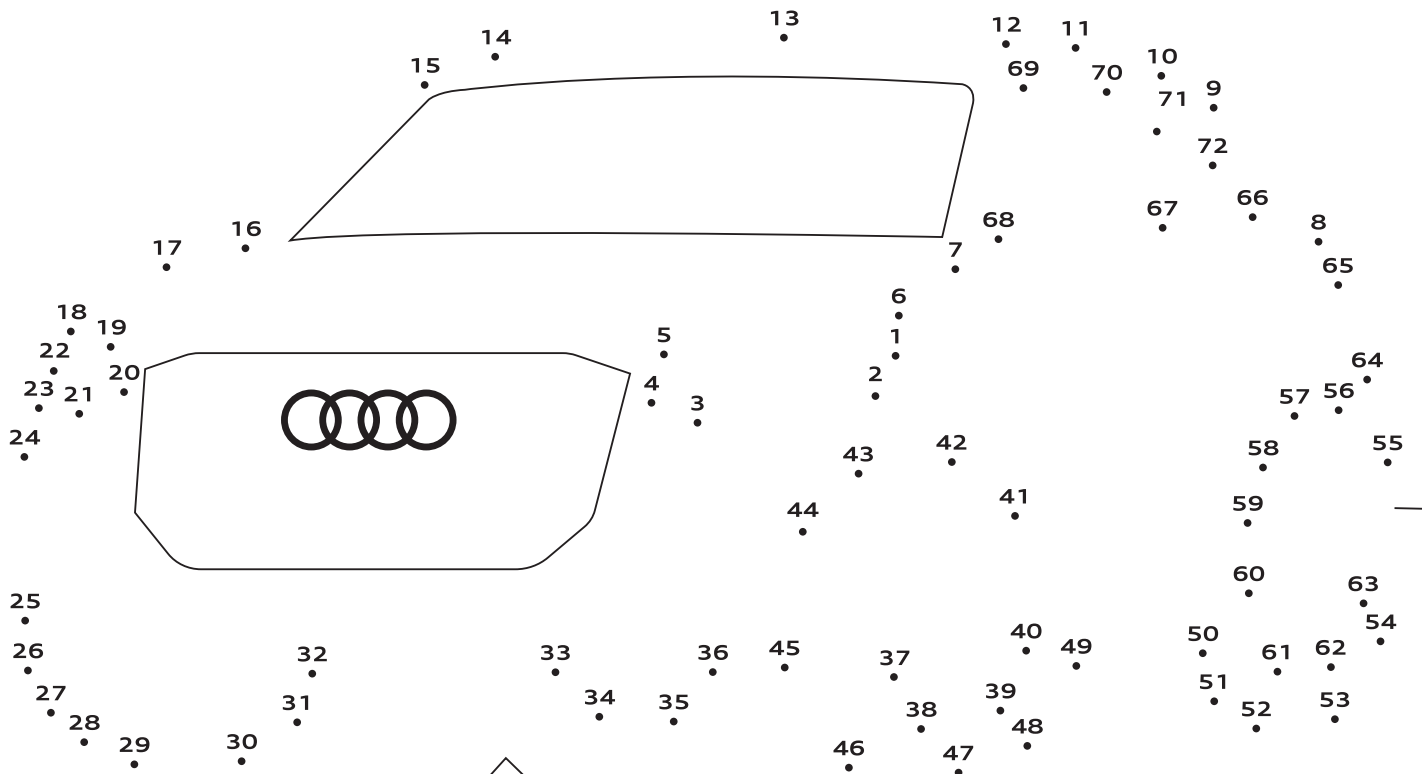
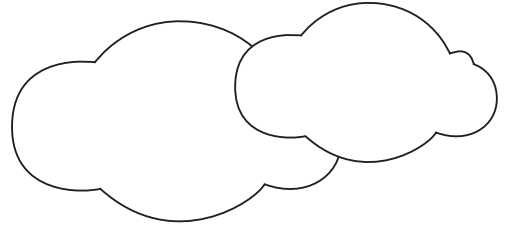

**Verbinde die Zahlen
und erfahre was
ADUI auflädt.**

Join up the numbers
and find out what
ADUI is recharging.

☒接数字，看看ADUI在☒什么充☒。

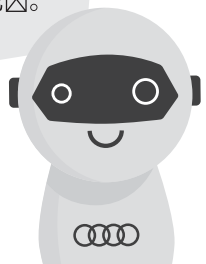

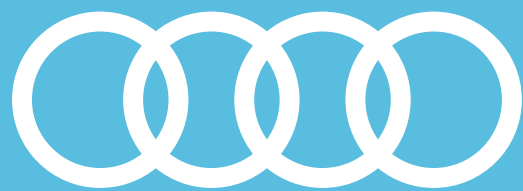

Auf Wiedersehen!

Bye bye! 再見!

